



PREMIUM-WERKZEUGE



PREMIUM TOOLS



DAF - IVECO - SPECIAL TOOLS



455.0110

COMMERCIAL VEHICLE COOLING SYSTEM TESTING EQUIPMENT

- For the diagnosis of leakages on coolant systems
- 7 adaptors ≈ 85% coverage of all commercial vehicles
- Optimal and safe seat like original cover
- Manometer with protective rubber cap
- Metall hand pump and flexible tube with decompression valve
- Sturdy design
- Special tool steel

9
pcs



287,90 €

COOLING SYSTEM EXPANDER CONE TEST ADAPTER

- For testing pressure and diagnosing leaks in the coolant system
- Also suitable for filling the cooling system alongside a filling valve
- The pressure generated holds the matching rubber cone in the cooler or expansion tank opening
- Can be fitted directly onto the cooler or expansion tank
- Secure fit due to expansion
- No need to purchase expensive individual adapters
- Removes need to purchase single adapters
- Simple handling
- Optimal use alongside KS Test pump 455.0111
- Robust design made from POM (polyoxmethylen)



	Ø mm	Height mm	
455.0141	17,0 - 37,0	170,0	€ 51, ⁵⁰
455.0142	28,0 - 41,0	170,0	€ 52, ⁵⁰
455.0143	37,0 - 50,0	170,0	€ 53, ⁵⁰
455.0144	47,0 - 60,0	170,0	€ 54, ⁵⁰

460.5245

INJECTION SOCKET FOR DAF

- 12 point
- Ideally suited for dismantling and mounting the union nut on high-pressure lines on the injection valve of the common rail system
- with side window and open for use on injection lines
- Internal square to DIN 3120 / ISO 1174 with ball reception
- For manual operation
- Burnished
- Special tool steel

Application range: DAF with Euro 6 e.g. XF and CF (engine: MX11/MX13)



26,90 €

Profile size mm	Ø mm	Length mm
21	34	90,0

460.3745

SEALING RING MOUNTING KIT FOR DAF

- for the assembly of sealing rings
- especially for the front crankshaft radial seal ring with a height of 16 mm, inner diameter 70 mm, outer diameter 100 mm
- Including retraction tool
- Special tool steel

Application range: DAF (CF65, LF45, LF55, SB), Irisbus (Euromidi, Europolis, Midirider, Proway), Iveco (Eurocargo I-III, Eurofire, Tector, Vertis), Kamaz 4



5
pcs

154,50 €

460.3670

INJECTOR SERVICE KIT FOR DAF

- For assembly and disassembly of valve springs and valves
- with mounted or dismantled cylinder head
- time- and cost-efficient
- Removal of cylinder head not necessary for repair of valve shaft seals or valve springs
- Fixing via pump-nozzle guide
- Special tool steel

Application range: DAF (CF85)

3
pcs



236,50 €

460.4030

SEALING RING MOUNTING KIT FOR DAF

- for the assembly of sealing rings
- especially for the front crankshaft radial seal with a height of 16 mm, inner diameter of 134 mm and outer diameter of 161 mm
- drawing tool
- Special tool steel

Application range: DAF (CF85, CF, XF105, XF), Solaris Vacanza



7
pcs

245,50 €

*This is an limited special price offer - only until stocks last.

All prices are ex. VAT. With the release of this leaflet all previous prices became invalid. Sold only in specialist stores. Print mistakes, errors and technical alterations excepted. Prices valid up to 30.09.2024

460.3680

SEALING RING MOUNTING KIT FOR DAF

- for the assembly of sealing rings
- especially for the front crankshaft radial seal ring with a height of 16 mm, internal diameter 166 mm, external diameter 191 mm
- Including retraction tool
- Special tool steel

7 pcs

Application range: DAF (CF85, CF, XF105, XF), Irizar (i3, i4, i6, i8, PB), Solaris Vacanza, Van Hool (Acron, Altano, Astromega, Astron, Astronef, EX Series, T Series), VDL (Futura, Jonkheere)



253,50 €

455.0106

ENGINE CAMSHAFT ROTATOR FOR DAF

- Allows the engine crank to be manually adjusted
- Allows pinpoint accuracy calibration
- Ideal for adjustments to the engine
- Internal square drive to DIN 3121 / ISO 1174
- Special tool steel

Application range: XF105 Euro5 etc.



38,50 €

Quantity Teeth	D1 mm	D2 mm	L mm
9	27,0	33,0	81,0

460.3980

ENGINE SPINNING DEVICE FOR IVECO

- With 6 point drive SW22
- Allows the engine crank to be manually adjusted
- Allows pinpoint accuracy calibration
- Ideal for adjustments to the engine
- Special tool steel

Application range: Iveco Euro Cargo, Cargo 150E27R PR, FPR, 320E27T, PT Eurotech, Eurostar



218,50 €

6-point mm	Quantity Teeth	A mm	B mm	H mm
22	13	105,0	70,0	125,0

455.0105

ENGINE CAMSHAFT ROTATOR FOR DAF

- Allows the engine crank to be manually adjusted
- Allows pinpoint accuracy calibration
- Ideal for adjustments to the engine
- With external drive hexagonal socket 24.0 mm
- Special tool steel

Application range: e.g. 65CF, 75CF, 85CF, 95XF, CF75, CF85,F65, F75, F85, F95, XF95



74,90 €

6-point mm	Quantity Teeth	L mm	B mm	H mm
24	11	90,0	40,0	90

460.5610

ENGINE SPINNING DEVICE FOR IVECO

- With 6 point drive SW22
- Allows the engine crank to be manually adjusted
- Allows pinpoint accuracy calibration
- Ideal for adjustments to the engine
- Special tool steel

Application range: Iveco Euro Cargo, Cargo models, Eurotech, Heavy, Off-Road, Bus

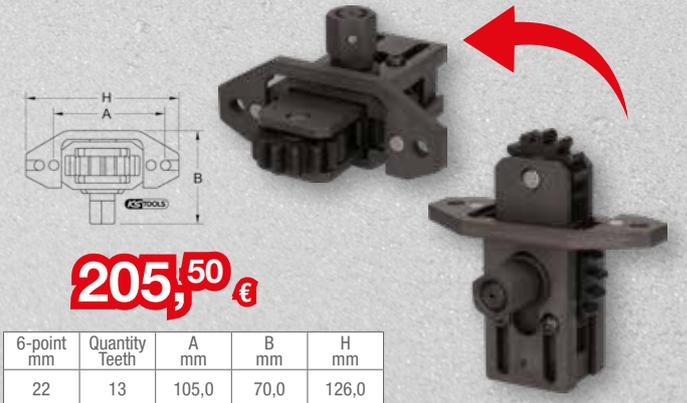

205,50 €

6-point mm	Quantity Teeth	A mm	B mm	H mm
22	13	105,0	70,0	126,0



HEXAGON IMPACT SOCKET

- ideally suited for mounting and dismounting screws on the flywheel
- 6 point
- According to DIN 3129 / ISO 2725-2
- Internal square drive to DIN 3121 / ISO 1174
- Short execution
- For machinery usage
- Phosphate finish
- Chrome molybdenum

Application range: MAN TGA, TGX, TGS, Iveco Euro Trakker and Euro Tech

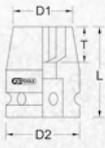

1/2"



	Spanner width mm	L mm	D1 mm	D2 mm	T mm	
515.1019	19,0	38,0	28,0	28,0	13,0	€ 3, ⁵⁰
515.1021	21,0	38,0	30,0	30,0	14,0	€ 3, ⁵⁰
515.1024	24,0	38,0	34,0	30,0	15,0	€ 4, ⁵⁰

PISTON RING INSTALLATION AID FOR DAF

- facilitates mounting of the piston in the liner
- conical mounting sleeve with centring
- Enormous time and cost saving
- Special tool steel



	D1 mm	D2 mm	
460.1095	137,0	130,0	€ 63, ⁵⁰
460.3675	134,0	130,0	€ 60, ⁹⁰

460.1815

CYLINDER LINER EXTRACTOR SET

- Ideal for removing of cylinder liner in commercial vehicles and industrial bearing
- Outriggers suitable especially for large cylinder liners and bearings
- Suitable for cylinder liner with \varnothing 60 – 160 mm
- Solid state
- 3 spreader guarantee an optimal adjustment of the internal extractor
- Extremely robust spindle with inductively hardened thread
- Lower power usage
- Enormous time and cost saving
- Special tool steel
- In durable plastic storage case

Application range: Cylinder liner on MAN, Mercedes etc.

6
pcs



\varnothing 60 - 160 mm



528,⁵⁰ €



460.0830

CYLINDER LINER EXTRACTOR SET

- Ideal for removing of cylinder liner in commercial vehicles and industrial bearing
- Outriggers suitable especially for large cylinder liners and bearings
- suitable for cylinder liners with inner-Ø 119 - 136.5 mm
- Solid state
- Optimum fit of the internal extractor for different vehicle manufacturers
- Extremely robust spindle with inductively hardened thread
- Lower power usage
- Enormous time and cost saving
- Special tool steel
- In durable steel storage case

Application range: Cylinder liners on Fuso 3.5t, 15t, 330, Hino 750, Scania 310, Volvo FL10, FM12, DAF and buses

14
pcs



1209,⁵⁰ €



*This is an limited special price offer - only until stocks last.
 All prices are ex. VAT. With the release of this leaflet all previous prices became invalid. Sold only in specialist stores. Print mistakes, errors and technical alterations excepted. Prices valid up to 30.09.2024



460.0850

UNIVERSAL ENGINE AND GEAR HOLDER WITH ROTARY FUNCTION

- ideally suited for work on dismantled engines, transmissions and differential gears
- Interchangeable mounting plates optionally available
- Mounting plate 360° rotatable by hand crank
- Stable construction
- Left- and right-hand rotation
- safe stand due to five rotating feet
- low space requirement when retracted
- Distance of telescopic arms 775 mm

**MAX. LOAD:
1.360 KG**

1.350 mm

1.150 - 1.600 mm

1.000 mm



9833,50 €

460.5550

MOTOR MOUNTING PLATE FOR DAF

- Ideally suited to working on removed engines
- Stable construction
- Special tool steel
- for use with universal motor and gear holder (460.0850)



405,50 €

460.4185

COMPRESSOR BEARING SPECIAL SOCKET FOR DAF

- Ideally suited for removing the screw from the rear compressor bearing
- 11-point
- With 1/2" square drive
- Chrome molybdenum

Application range: DAF 85 (CF)



65 mm

1/2"

37,50 €



460.3735

TRANSMISSION INPUT SHAFT SEAL INSTALLATION TOOL FOR DAF

- Washer installation aid for manual use
- For damage free mounting
- Extremely versatile
- Special tool steel

Application range: DAF LF55, CF65 (gearbox input shaft)



96,50 €

Internal Ø mm	External Ø mm	Length mm
49,0	65,0	245,0

460.0735

GEAR BOX ASSEMBLY AND DISASSEMBLY SET FOR MAN / MERCEDES ZF 16S

- For assembly and disassembly of the ZF 16S gear box
- Extremely sturdy execution
- Special tool steel
- In durable metal case

Application range: Assembly and disassembly of the ZF 16S gear box (Mercedes, DAF, etc.)

8 pcs



1915,50 €

450.0330

VIBRO-IMPACT UNIVERSAL BALL JOINT PULLER BELL 58 X 115 MM

- Trapezoidal spindle
- High release force due to rotary shock pulse with impact wrench
- Impact screws create pressure and vibration at the same time, through which the secure ball joint connections and quickly and safely removed
- Less space required
- Cast forged execution
- With inspection panel
- Internal square drive to DIN 3120 / ISO 1174
- Special tool steel

Application range: e.g. DAF / Scania and other european commercial vehicle

3/4"

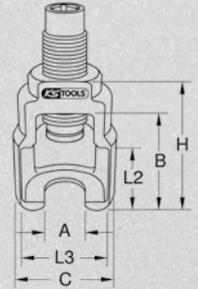

570,50 €

A mm	B mm	C mm	H mm	L2 mm	L3 mm
58,0	115,0	137,0	162,0	70,0	115,0



*This is an limited special price offer - only until stocks last.

All prices are ex. VAT. With the release of this leaflet all previous prices became invalid. Sold only in specialist stores. Print mistakes, errors and technical alterations excepted. Prices valid up to 30.09.2024



460.3620

KINGPIN PRESS 75T WITH SET OF SLEEVES

- Suitable for quick insertion and removal of king pins
- Ideal for cylindrical and conical bolts
- No removal of the axle required
- Press unit is 360° rotatable
- Open width 260 mm
- Swivelling, rotatable and with height adjustment for components that are difficult to access
- Including pneumatic hydraulic foot pump with quick lift, hydraulic cylinder, most common sleeves and pressure pieces
- Secure and easy to use
- Special and compact design
- time- and cost-efficient

29
 pcs

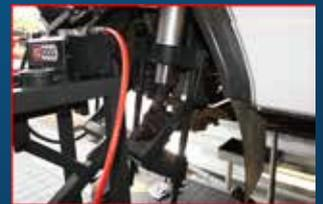

Ø 24 mm

Ø 34 mm

Ø 47 mm

Ø 47 mm

Ø 47 mm

Ø 39 mm

Ø 50 mm

Ø 61 mm

Ø 95 mm



Technical data:

Capacity: 75 t
 Stroke: 160,0 mm
 Operating pressure max.: 700 bar
 Volume: 1,8 l

4449,⁹⁰ €

460.3925

DOUBLE WISHBONE BUSHES SET FOR DAF Ø 70 MM

- For mounting and dismantling the bushings on the wishbone of the rear axle
- Suitable for the front bearing and for the rear bearings with Ø 70mm
- Secure and easy to use
- In conjunction with a workshop press
- Special tool steel

Application range: DAF wishbone at the rear axle



8
pcs

460.0610

SLOTTED NUT WRENCH FOR STEERING LINKAGE FASTENING WITH 4 PINS FOR DAF

- ideal for tightening and loosening groove nuts on steering rods
- Internal square drive to DIN 3121 / ISO 1174
- High accuracy of fit
- Extremely robust version
- Slim design
- Suitable for exact torque possible
- Special tool steel

1/2"

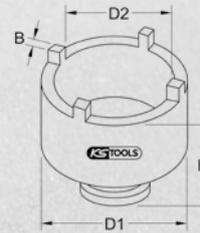

52,50 €

D1 mm	D2 mm	Number of studs	B mm	Height mm
52,0	41,0	4	5,0	78,0

460.3820

SPECIAL 12-SIDED KEY FOR IVECO

- 12-sided special wrench
- for mounting and dismantling the steering column screw connection
- Extremely robust
- Special tool steel

Application range: Iveco 12 t, 17 t



84,50 €

Spanner width mm	Length mm
65	300,0



460.4160

SOCKET AND WISHBONE SET FOR DAF Ø 75 MM

- For mounting and dismantling the bushings on the wishbone of the rear axle
- Suitable for the front and rear bearings with Ø 75mm
- Secure and easy to use
- In conjunction with a workshop press
- Special tool steel

Application range: DAF wishbone at the rear axle



8
pcs

460.4190

AXLE NUT SOCKET FOR DAF

- Internal square drive to DIN 3121 / ISO 1174
- 6 point
- Any extensive slipping is avoided
- Extremely robust version
- Suitable for high tightening and loosening torque
- Can be used with an impact wrench or torque wrench
- Chrome molybdenum

Application range: DAF (CF) EURO 5 drive axle nut

1"

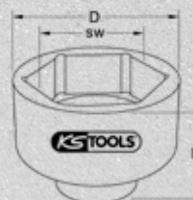

278,50 €

Spanner width mm	D mm	Height mm
120,0	158,0	106,0



460.1085

WRENCH WITH 6 PINS FOR DAF

- Internal square drive to DIN 3121 / ISO 1174
- High accuracy of fit
- Special profile with 6 internal studs
- Extremely robust version
- Suitable for high tightening and loosening torque
- Special tool steel

Application range: DAF CF85 transmission (EURO 4 and EURO 5)

3/4"

115,50 €

Height mm	D1 mm	D2 mm	D3 mm	Number of studs	B mm
55,0	91,0	74,0	66,0	6	6,7

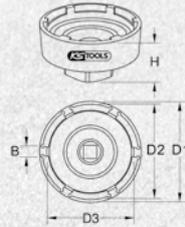

460.5333

AXLE NUT WRENCH FOR IVECO

- Internal square drive to DIN 3121 / ISO 1174
- 6 point
- High accuracy of fit
- Extremely robust version
- Suitable for high tightening and loosening torque
- Special tool steel

Application range: Iveco Euro Cargo HA

3/4"

223,90 €

Spanner width mm	Ø mm	Height mm
90	117	69,0



460.3730

WRENCH WITH 6 PINS FOR DAF

- Internal square drive to DIN 3121 / ISO 1174
- High accuracy of fit
- Special profile with 6 internal studs
- Extremely robust version
- Suitable for high tightening and loosening torque
- Special tool steel

Application range: DAF LF45 rear axle

3/4"

157,50 €

H mm	D1 mm	D2 mm	D3 mm	Number of studs	B mm	T mm
87,0	109,0	98,0	86,0	6	10,5	20,0



460.1040

AXLE NUT WRENCH FOR IVECO

- Six sided drive 36 mm
- 6 point
- Any extensive slipping is avoided
- Extremely robust version
- Suitable for high tightening and loosening torque
- Can be used with an impact wrench or torque wrench
- Special tool steel

Application range: Iveco Euro Cargo

3/4"

218,50 €

Spanner width mm	6-point mm	Ø mm	Height mm
98,0	36	122,0	115,0



460.4170

AXLE NUT IMPACT SOCKET FOR IVECO

- Internal square drive to DIN 3121 / ISO 1174
- 12 point
- Any extensive slipping is avoided
- Extremely robust version
- Suitable for high tightening and loosening torque
- Can be used with an impact wrench or torque wrench
- Special tool steel

1"

139,50 €

Spanner width mm	Ø mm	Height mm
85,0	83,0	58,0



450.0200

AXLE NUT WRENCH FOR IVECO

- Six sided drive 36 mm
- Positive drive of the axle nut
- Any extensive slipping is avoided
- Milled out profile
- Sturdy design
- Can be used with an impact wrench or torque wrench
- Special tool steel

Application range: Iveco Euro Cargo etc.

3/4"

236,50 €

Spanner width mm	6-point mm	D1 mm	T mm	Height mm
98,0	36	122,0	72,0	120,0





450.0203

AXLE NUT WRENCH FOR IVECO WITH GUIDE COLLAR

- Six sided drive 36 mm
- Positive drive of the axle nut
- Any extensive slipping is avoided
- Milled out profile
- Sturdy design
- Can be used with an impact wrench or torque wrench
- Special tool steel

Application range: Iveco Eurotech Cursor HA etc.



296,⁵⁰ €

Spanner width mm	External hexagon drive in mm	Ø mm	Height mm
110,0	36	133,0	116,0

460.4370

WHEEL BEARING INSTALLATION AID FOR DAF

- Ideally suited for mounting the wheel bearing and the sealing ring on the front axle
- Facilitates installation due to constant force
- time- and cost-efficient
- Special tool steel

Application range: DAF CF

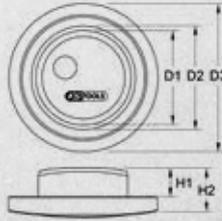

90,⁹⁰ €

D1 mm	D2 mm	D3 mm	H1 mm	H2 mm
73,5	81,5	137,5	22,6	35,0

460.4165

AXLE NUT SOCKET FOR IVECO

- Six sided drive 36 mm
- 12 point
- Any extensive slipping is avoided
- Extremely robust version
- Suitable for high tightening and loosening torque
- Can be used with an impact wrench or torque wrench
- Special tool steel

Application range: Axle nut Iveco Eurotech-Cursor



218,⁵⁰ €

Spanner width mm	External hexagon drive in mm	Ø mm	Height mm
105,0	36	128,0	116,0

460.4375

WHEEL BEARING INSTALLATION AID FOR DAF

- Ideally suited for mounting the wheel bearing and the sealing ring on the front axle
- Facilitates installation due to constant force
- time- and cost-efficient
- Special tool steel

Application range: DAF CF

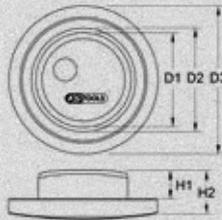

88,⁹⁰ €

D1 mm	D2 mm	D3 mm	H1 mm	H2 mm
61,5	69,5	124,5	22,6	35,0

460.5455

AXLE NUT WRENCH FOR RENAULT AND IVECO

- Internal square drive to DIN 3121 / ISO 1174
- 6 point
- High accuracy of fit
- Extremely robust version
- Suitable for high tightening and loosening torque
- Special tool steel

1"



211,⁹⁰ €

Spanner width mm	Ø mm	Height mm
80	100	137,5

460.4380

WHEEL BEARING INSTALLATION AID FOR DAF

- Ideally suited for mounting the wheel bearing and the sealing ring on the front axle
- Facilitates installation due to constant force
- time- and cost-efficient
- Special tool steel

Application range: DAF CF

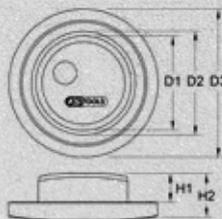

100,⁵⁰ €

D1 mm	D2 mm	D3 mm	H1 mm	H2 mm
91,5	99,5	147,5	22,6	35,0

*This is an limited special price offer - only until stocks last.

All prices are ex. VAT. With the release of this leaflet all previous prices became invalid. Sold only in specialist stores. Print mistakes, errors and technical alterations excepted. Prices valid up to 30.09.2024



460.1705

SLOT BUSHING TOOL SET FOR SILENT BEARING SLOT BUSHES

- Suitable for the installation and removal of the bearing bushes in commercial vehicle spring suspension
- The slotted bushes can be effortlessly preloaded using the clamping block and the accompanying half shells and thus adjusted to the installation dimensions
- Includes 12 t hydraulic cylinder, especially in the construction of fixed bushes
- The hydraulic cylinder is made for universal usage
- Supplied without hydraulic pump
- Optional: Hand pump 640.0010
- Optional: Air Hydraulic Pump 640.0020
- Optional: Electric Hydraulic Pump 640.0030
- Special installation method that protects the bush via parallel working tensioning elements
- The function of the bearing bush is retained
- Simple handling and quick assembly times
- Safe working
- Suitable for bush change directly on the vehicle

Application:

- Ø 51 mm - Volvo FM12
- Ø 60 mm - DB / Renault (430/450/460)
- Ø 68 mm - MAN-TGA (410/414/460) front axle spring ROR, SAF

19
pcs



Original *CEJIB



1947,50 €

640.0010

HYDRAULIC HAND PUMP

- Single stage
- Reverse valve for advance and return stroke
- Safety valve for overload protection
- Includes pressure tube 1.8 meters
- Usable tank volume 2081cm³ = 2.081l



1271,50 €

Connection thread	Length mm	Width mm	H mm	Output per stroke cm ³
3/8" - 18 NPT	585	133	119	2,62

640.0020

PNEUMATIC HYDRAULIC PUMP

- Pneumatic working
- For simply agent press cylinders
- Safety valve for overload protection
- Includes pressure tube 1.8 meters
- Usable tank volume 2081cm³ = 2.081l
- Operating pressure max. 700 bar
- Output per stroke:
0.8 l/min up to 200 bar
0.1 l/min up to 700 bar



2180,90 €

Connection thread	Length mm	Width mm	H mm
3/8" - 18 NPT	255	130	200

640.0030

ELECTRIC HYDRAULIC PUMP

- Two stepped for simply agent press cylinders
- Safety valve for overload protection
- Usable tank volume 1900 cm³ = 1.9l
- Includes pressure tube 1.8 meters
- Motor specification 0.37kW - 220/230 V - 50/60 hertz, single phase (3.2 amps)
- 1. Step: max. 13 bar
- 2. Step: max. 700 bar
- Output per stroke:
1. Step: 3.31 l/min
2. Step: 0.32 l/min



5878,50 €

Connection thread	Length mm	Width mm	H mm
3/8" - 18 NPT	244	244	362

*This is an limited special price offer - only until stocks last.

All prices are ex. VAT. With the release of this leaflet all previous prices became invalid. Sold only in specialist stores. Print mistakes, errors and technical alterations excepted. Prices valid up to 30.09.2024



PREMIUM-WERKZEUGE



PREMIUM TOOLS



Our commercial vehicle special catalogues



LL22-14D_EUR



LL22-14EN_EUR



LL22-12D_EUR



LL22-12EN_EUR



LL22-16D_EUR



LL22-16EN_EUR



LL22-15D_EUR



LL22-15EN_EUR



LL22-13D_EUR



LL22-13EN_EUR



460.1025

SLOTTED NUT WRENCH WITH 4 PINS FOR DAF

- Internal square drive to DIN 3121 / ISO 1174
- High accuracy of fit
- Special profile with 4 internal studs
- Extremely robust version
- Suitable for high tightening and loosening torque
- Special tool steel

Application range: DAF XLR (Euro 4) centre drive shaft bearing

3/4"

88,90 €

D1 mm	D2 mm	D3 mm	Number of studs	B mm	H mm
72,0	57,0	50,0	4	6,0	55,0



460.4155

DIFFERENTIAL MAIN SHAFT BEARINGS PULLER SET FOR DAF

- For damage-free mounting and dismounting of the differential's main shaft bearings
- Extremely sturdy execution
- Including 2 half-shell pairs
- Trapezoid thread spindle for high removal power - drive 30 mm
- Special tool steel

Application range: DAF (CF) 35 t

8 pcs



1155,50 €

460.3685

DIFFERENTIAL MAIN SHAFT BEARINGS PULLER SET FOR DAF

- For damage-free mounting and dismounting of the differential's main shaft bearings
- Extremely sturdy execution
- Including 2 half-shell pairs
- Trapezoid thread spindle for high removal power - drive 30 mm
- Special tool steel

Application range: DAF (CF) 35 t

10 pcs



903,50 €

460.3690

DIFFERENTIAL MAIN SHAFT BEARINGS PULLER SET FOR DAF AND SCANIA

- For damage-free removal of the main shaft bearings of the differential
- Extremely sturdy execution
- Including 4 half-shell pairs
- Trapezoid thread spindle for high removal power - drive 30 mm
- Special tool steel

Application range: DAF (CF) 35 t

14 pcs



1701,50 €

517.0926

SLOGGING 6 POINT SPANNER WITH 2 STRIKING FACES

- 6 point
- Ideal for loosening and tightening TORX® screws on brake calliper screw connections to the rear axle
- With 3/4 " square drive for the correct tightening of the screw
- With lasered troque formula for calculating the correct effective length
- With 2 impact area
- Phosphate finish
- Chrome vanadium

3/4"

3/4"

26 mm

226 mm

Spanner width mm	A mm	B mm	L mm
26	12,0	52,0	226,0



52,50 €

**460.5281****OIL SERVICE SPECIAL PROFILE TOOL FOR PLASTIC OIL DRAIN PLUGS DAF AND MAN**

- Special profile
- Special Bits for Assembly and Disassembly of Plastic Oil Drain Screws on Plastic Oil Sump
- External hexagon drive to DIN 3126 / ISO 1173 - C 6,3
- Custom-fit profile to ensure correct operation
- For manual operation
- Phosphate finish
- Special tool steel

**14,90 €**

6-point mm	Profile size mm
17	8,5

430.0619**OIL DRAIN PLUG FOR DAF AND MAN**

- Hexagon socket
- With washer

**12,90 €**

Content	mm
1	8,5

430.0610**OIL DRAIN PLUG M22 X 1.5 X 21 MM FOR IVECO**

- External hexagon
- With washer

**11,90 €**

Content	mm
1	33

430.0611**OIL DRAIN PLUG M22 X 1.5 X 16 MM FOR IVECO**

- Hexagon socket
- With washer

**14,90 €**

Content	mm
1	12

430.0612**OIL DRAIN PLUG M22 X 1.5 X 13 MM FOR IVECO**

- Hexagon socket
- With washer

**31,50 €**

Content	mm
1	12

430.0616**OIL DRAIN PLUG M22 X 1.5 X 17 MM FOR DAF**

- Internal square
- With washer

**41,90 €**

Content	mm
1	10

430.0617**OIL DRAIN PLUG M22 X 1.5 X 18 MM FOR DAF**

- Hexagon socket
- With washer

**50,90 €**

Content	mm
1	12

430.0618**OIL DRAIN PLUG M26 X 1.5 X 20 MM FOR DAF**

- External hexagon
- With washer

**23,90 €**

Content	mm
1	22

HUB NUT CENTERING AND PROTECTING SLEEVES SET

- For fast disassembly and assembly of truck tyres
- To fix the brake drum
- No slipping while the disassembly and assembly
- Protects hub nut threads
- Exact centering of the wheel to hub nut
- Special tool steel

Application: DAF, Unimog, Iveco, MAN, Renault, Volvo



	Content	Rim hole Ø mm	Length mm	Jaw opening inche	Spanner width mm	
450.0372	M18x1,5	3	21,0	100,0	1/2"	€ 68,50
450.0373	M18x1,5	3	24,0	100,0	1/2"	€ 70,90
450.0370	M22x1,5	2	26,0	145,0	19,0	€ 93,50

*This is an limited special price offer - only until stocks last.

All prices are ex. VAT. With the release of this leaflet all previous prices became invalid. Sold only in specialist stores. Print mistakes, errors and technical alterations excepted. Prices valid up to 30.09.2024

...AND YOU WANT MORE?

PREMIUM-WERKZEUGE
KS TOOLS
PREMIUM TOOLS

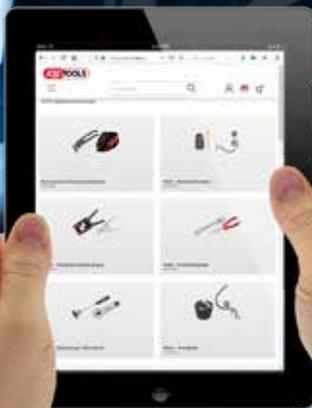

WWW.KSTOOLS.COM

SPECIAL TOOLS FOR COMMERCIAL VEHICLES AND TRANSPORTER

23 CHAPTER

4.672 ARTICLES

528 PAGES



Your Local Distributor

PREMIUM-WERKZEUGE
KS TOOLS
PREMIUM TOOLS

KS Tools Werkzeuge - Maschinen GmbH

Seligenstädter Grund 10 - 12
D-63150 Heusenstamm

 GERMANY

Tel.: +49(0) 61 04 49 74-0

Fax: +49(0) 61 04 49 74-11

e-mail: aftersales@kstoools.com

www.kstoools.com



LL22-14EN_EUR

*This is an limited special price offer - only until stocks last.

All prices are ex. VAT. With the release of this leaflet all previous prices became invalid. Sold only in specialist stores. Print mistakes, errors and technical alterations excepted. Prices valid up to 30.09.2024